

OptiSquare 4x4 - IESNA Type 4

35.116 · 4x4 · Optics for street and area lighting

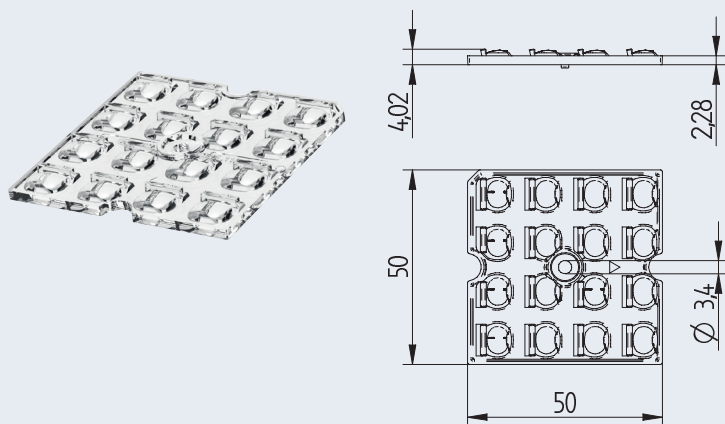

OptiSquare 4x4 MidPower - IESNA Type 4
Optics for street and area lighting
for use with LED modules according to Zhaga Book 15

Light distribution: IESNA Type 4

Material: PMMA (clear)
Screw fixing: Screws M3
Maximum torque: 0.5 Nm

Suitable for LED chips 3030, 2835 and LED modules
according to Zhaga Book 15

Typical application:

- Walkways, paths and sidewalks
- Entrance roadways
- Loading and access ramps
- General road and street lighting
- Car parks and parking area lighting
- Perimeter of parking areas
- Center of roadways and intersections

Height	4.02 mm
Width	50 mm
Length	50 mm
Type of fixing	Screw fixing: (0.5 Nm) for screws M3
LED type	3030, 2835
Pitch distance	12.5 mm
Material	PMMA
Colour	clear
Lens surface	highly polished
Optical efficiency	see below
Permissible application temperature	-40 °C up to + 80 °C

pkg.	wt.	part no.
200	8,2 g	35.116.1004.85

The presented information are for reference only. All lighting parameters are typical values.
The light distribution depends on the used Type of LEDs, position tolerance, chip size and used colour.

-40°C
+80°C CAD

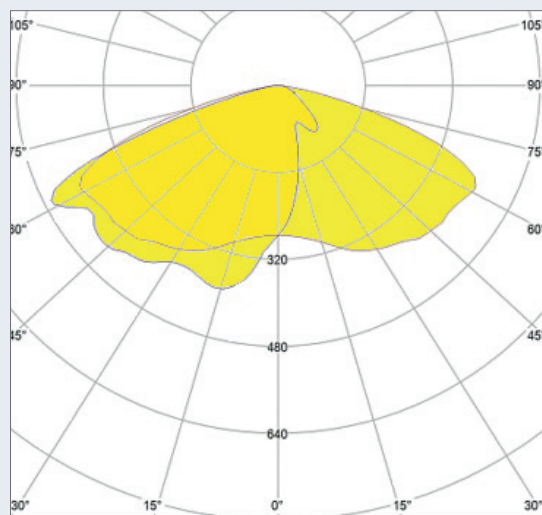

Light distribution: IESNA Type 4
measured with Philips Fortimo FastFlex LED 4x16 DHE G4

Efficiency: 97%

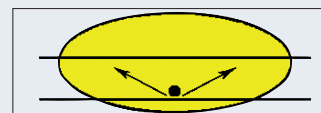

schematic illustration of the light distribution