

Alu-Socket for Spot - Downlight Modules GH36d-5

32.920 - Alu-Socket for Spot - Downlight Modules GH36d-5

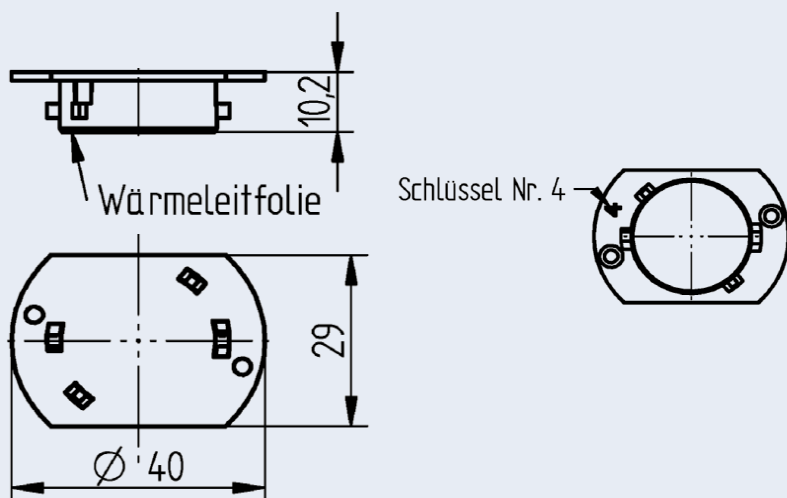

Part no.
32.920.3005.36

Alu-Socket for Spot - Downlight Modules GH36d-5

- Twist and Lock System

Maximum power depends on the respective heat sink, but max. 32 W.

Mechanical data	
Height	10,2 mm
width	29 mm
length	Ø 40 mm
Code	5
Material data	
Material	Aluminium
TIM between Alu_Socket and heat sink	graphite foil
Weight	16 g
Electrical data	
Max.	Max. 32 W (typ. 900 mA)
Commercial data	
Packaging quantity	250
Environmental requirements	
Max. Operating temperature	140°C

Countersunk screws	M2,6x4 cross recess
Packaging quantity	1000
Weight	0,123 g

Part no.
32.920.-801.12

- 2 countersunk screws M2.6x4 cross recess nickel-plated each for fastening the lower part to be ordered separately.