

OptiSquare 8in1 - IESNA Type 1

35.108 · 8in1 · Optics for street and area lighting

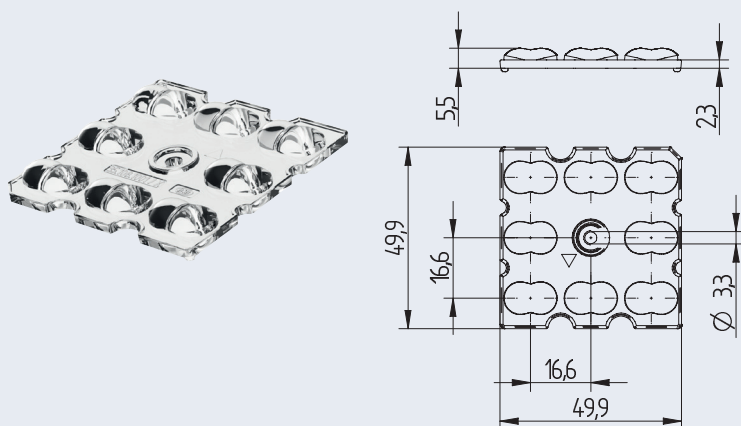

OptiSquare 8in1 CSP - IESNA Type 1
Optics for street and area lighting
for use with LED modules according to Zhaga Book 15

Light distribution: IESNA Type 1

Material: PMMA (clear)
Screw fixing: Screws M3
Maximum torque: 0.5 Nm

Suitable for CSP (Chip Scale Package) LED chips and LED modules according to Zhaga Book 15

Typical application:

- Walkways, paths and sidewalks
- Entrance roadways
- Loading and access ramps
- General road and street lighting
- Car parks and parking area lighting
- Perimeter of parking areas
- Center of roadways and intersections

Height	5.5 mm
Width	49.9 mm
Length	49.9 mm
Type of fixing	Screw fixing: (0.5 Nm) for screws M3
LED type	CSP-Chips and LED modules according to Zhaga Book 15
Pitch distance	16.6 mm
Material	PMMA
Colour	clear
Lens surface	highly polished
Optical efficiency	see below
Permissible application temperature	-40 °C up to 80 °C*

pkg.	wt.	part no.
500	8.3 g	35.108.1001-0

The presented information are for reference only. All lighting parameters are typical values.
The light distribution depends on the used Type of LEDs, position tolerance, chip size and used colour.

* 70°C, if ball pressure test according to EN 60598-1 section 13.2.1 is required for components that ensure protection against electric shock

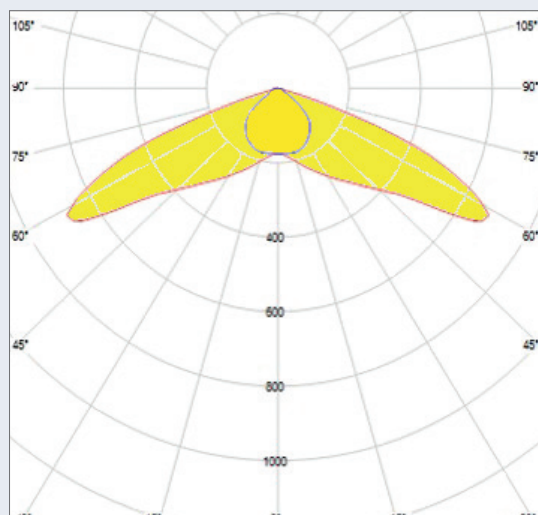

Light distribution: IESNA Type 1
measured with Philips Fortimo FastFlex LED 4x8up PR G5

Efficiency: 97%

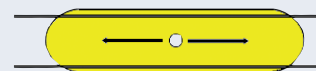

schematic illustration of the light distribution